



SIMONTON
Reflections[®]

INSTALLATION INSTRUCTIONS

Read all instructions thoroughly before beginning the installation of the window. These instructions are intended as a basic guide for installing replacement windows. If you require more in-depth instructions covering a specific window style or are installing windows in a new construction application, please contact your Simonton representative.

- 1 a. Before removing old unit inspect new unit for correct size, type, damage and correct installation information for your application. If a problem exists with any of these areas contact your distributor before installing.
- b. Begin by measuring the window to be replaced. Measure at three locations: top, middle and bottom of the window on width, and right, center and left on height. Use the smallest of these measurements to determine the width and height. Do not remove the old window until the dimensions of the new window have been verified to fit the opening properly and you have all the accessories needed.
- c. Check opening for square by measuring diagonally. If unit is out of square additional cut backs may be required.

Accessories are available from Simonton to ease the installation and finishing of the new window. For more information on accessories and their applications, contact your Simonton supplier.

- 2 Remove the old window and prepare the opening (leveling off the sill if necessary). It is important to remember that the replacement window must fit into the opening plumb, level and square, even though the opening may not be any of these. If the window is not plumb, level and square the following problems may occur:
 - Double Hung and Slider sash may be difficult or impossible to remove.
 - Casement sash may not operate properly due to excessive drag on the sill.
 - The sash pivot bar on Double Hung windows could bind and cause the sash to become inoperative.
 - The overlapping and interlocking meeting rail on Double Hung and Slider windows may not perform properly — allowing air and water infiltration, even if the sash is locked.
 - The weatherstripping may not seal properly, allowing air and water infiltration.
 - The partial-ventilation latch on Slider windows may drag on the center leg of the sill or be inoperative.
 - The locking system may not engage properly.
- 3 When installing in a slope sill application, place wood blocks along the existing windowsill. The blocks will help support the window and keep the sill level. Also, wrap the entire perimeter of the window with insulation. If gaps between the unit and the opening are less than 1/8" the unit may not require insulation. When this occurs Simonton recommends an exterior and interior perimeter seal to create a dead air space.
- 4 Attach the sill extender (if necessary) to the bottom of the sill and trim it to fit in the opening. Be careful not to cut the sill extender too tight to prevent deflection of sill. Sill extender should not be used as support.
- 5 Tilt the window up into the opening with the sash closed and locked. Set it down on the wood blocks placed along the windowsill.
- 6 Tighten the adjustment devices (alignment clips, jamb adjusters, etc.) and shim the wood blocks to hold the unit secure while checking it for plumb, level, and square. Be careful not to over tighten jamb adjusters to avoid twisting or deflection of jambs.
 - **To check plumb:** Place a level vertically on both the interior and face of the left and right jambs. If the bubble indicator is centered, the unit is plumb (Fig. A).
 - **To check level:** Place a level along the sill. If the bubble indicator is centered, the unit is level (Fig. B).
 - **To check square:** Measure window frame diagonally. Measure from the top left corner of the frame to the bottom right corner and from the top right to bottom left. If the measurements are equal, the window is square (Fig. C). You can also check the squareness by closing the sash to the point where it just meets the head or sill. If both sides of the sash meet the head or sill at the same time, the window is square.

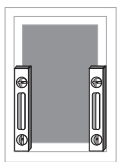

Fig. A

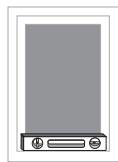

Fig. B

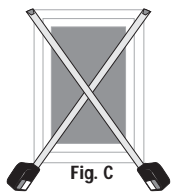

Fig. C

- 7 Check the sash where they meet the frame to be certain the weatherstripping is sealing properly in all areas. Inspect all weatherstripping to insure it has not pulled out of the receiver channel. To reinstall it, pull the stripping completely out of the channel then reinsert it by sliding the spline into the receiver channel. Check for an even reveal (gap) between the sash and the frame.
- 8 Once the window is plumb, level and square, install installation screws (provided by Simonton) into the prefabricated installation holes in the jambs. Shims should be used to establish spacing at anchoring points and should be penetrated by the installation screw. **DO NOT OVER TIGHTEN THE SCREWS**, as this could cause the frame to bow. Recheck the sash for proper operation once the screws have been installed. Caulk and cover the installation holes when necessary.

Note: When installing Casements, place screws in the installation holes. Replace existing screws closest to the center of the sill on both hinge tracks with installation screws. Prior to replacing the screw in the sill with the installation screw, fill the hole with sealant, and then run the installation screw into the hole. Seal the head of the screw to be sure this remains watertight (Fig. D). Replace a screw in each tie bar guide with installation screws (Fig. E). After the window is secured, recheck the sash operation and the weather seals. With awnings, replace one of the center screws in the operator assembly with an installation screw (Fig. F). Replace the second screw from the top and the closest screw to the bottom on the hinge tracks with installation screws (Fig. G). Install installation screws in the predrilled installation holes in the head. After the window is secure, recheck the sash operation and weather seals.

- 9 If installing large windows or windows with high wind load requirements, install interior and exterior blind stops along the jambs, head and sill (if not already present). The blind stops must be a minimum of 3/4" by 1/2".
- 10 Finish off the exterior of the window. Seal the entire perimeter of the window with the proper grade of sealant. Trim and cap off where necessary. Do not cover weeps.
- 11 Make certain sash open, close and lock properly. Operable slider sash should lift off freely. Finish off the interior of the window.

- 12 **Remember:** The homeowner is the final inspector. Clean the window well and remove all debris from the job site. Be sure the homeowner is familiar with the proper operation and all the features of the window.

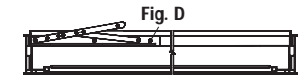

Fig. D

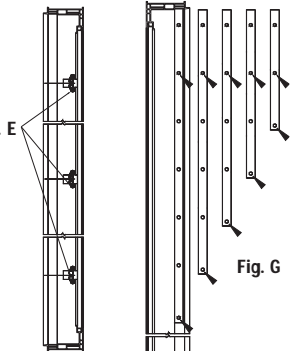

Fig. E

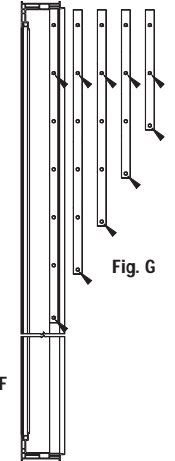

Fig. G

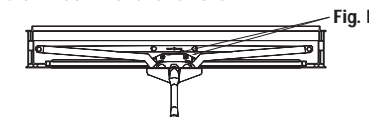

Fig. F

Features of the Reflections® by Simonton product line include:

- The Lap-Lok® overlapping interlocking meeting rail.
- The triple-stepped, sloped Simonton Sill® design.
- The Air Lok™ ventilation system.
- The Denny Clip™ pivot system.

 **SIMONTON**
W I N D O W S
We make lasting impressions.®

Simonton Windows®, Reflections®, Simonton Sill®, Lap-Lok® and We make lasting impressions.® are registered trademarks and Air Lok™ and Denny Clip™ are trademarks of Simonton Building Products, Inc. The meeting rail is manufactured under U.S. Patent 5,446,997.

©2002 Simonton Building Products, Inc.

080102334001

080102334001